

X4007-05/01 - Pigeon Hole Locker 5 Compartments

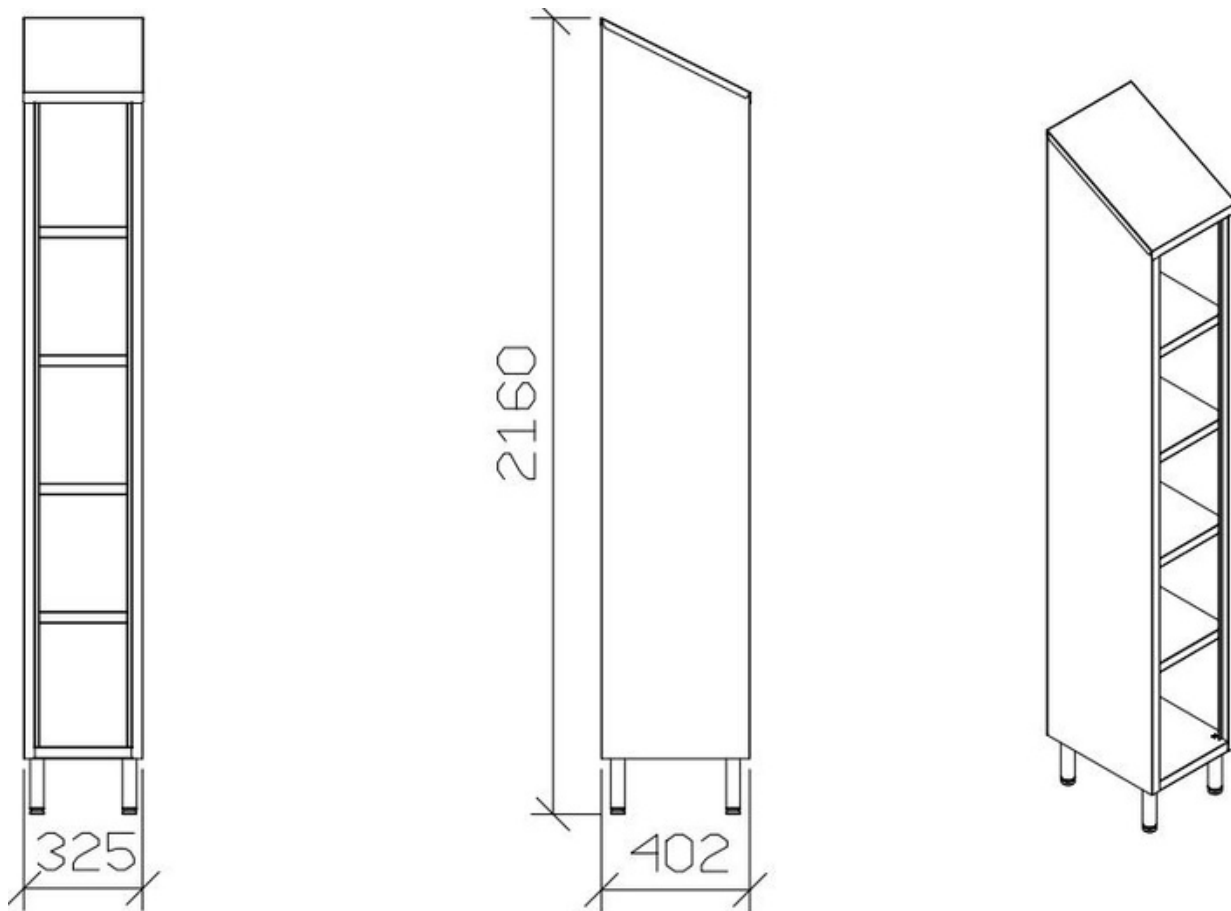

- Stainless steel AISI 304 or AISI 441
- Sloping Top
- 5 Open Compartments without doors
- Adjustable feet $\varnothing 38\text{mm} \times 150\text{H}$
- Dimension mm 325 x 400 x 1.950 / 2.150H