

X4250 - 5 Drawer Cabinet

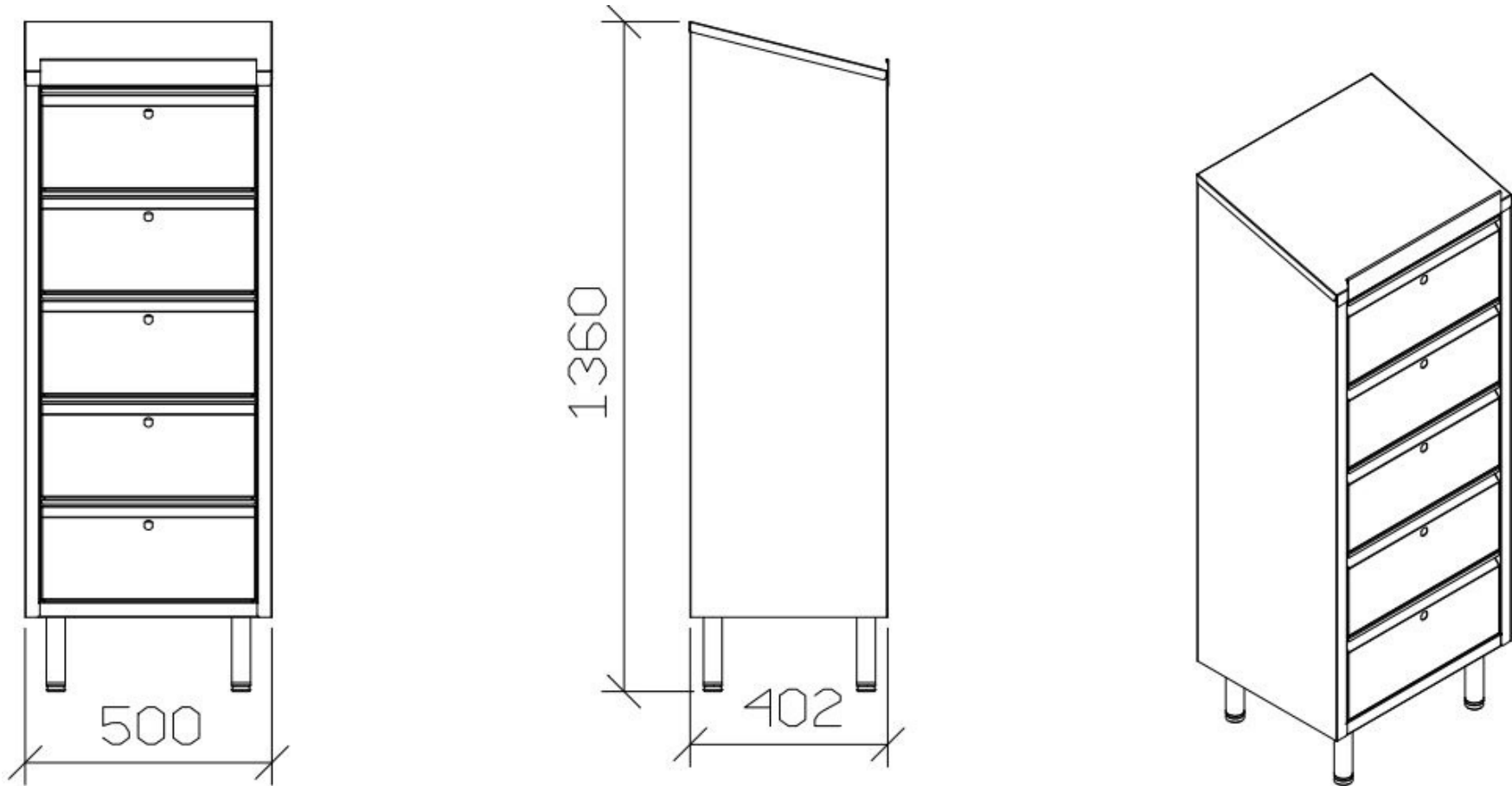

- Stainless steel AISI 304 or AISI 441
- Inclined writing top with raised front edge
- 5 Drawers with key lock

- Adjustable feet $\varnothing 38\text{mm} \times 150\text{H}$
- Dimension mm 500 x 400 x 1.360H