

X4380 - 6 Drawer Cabinet

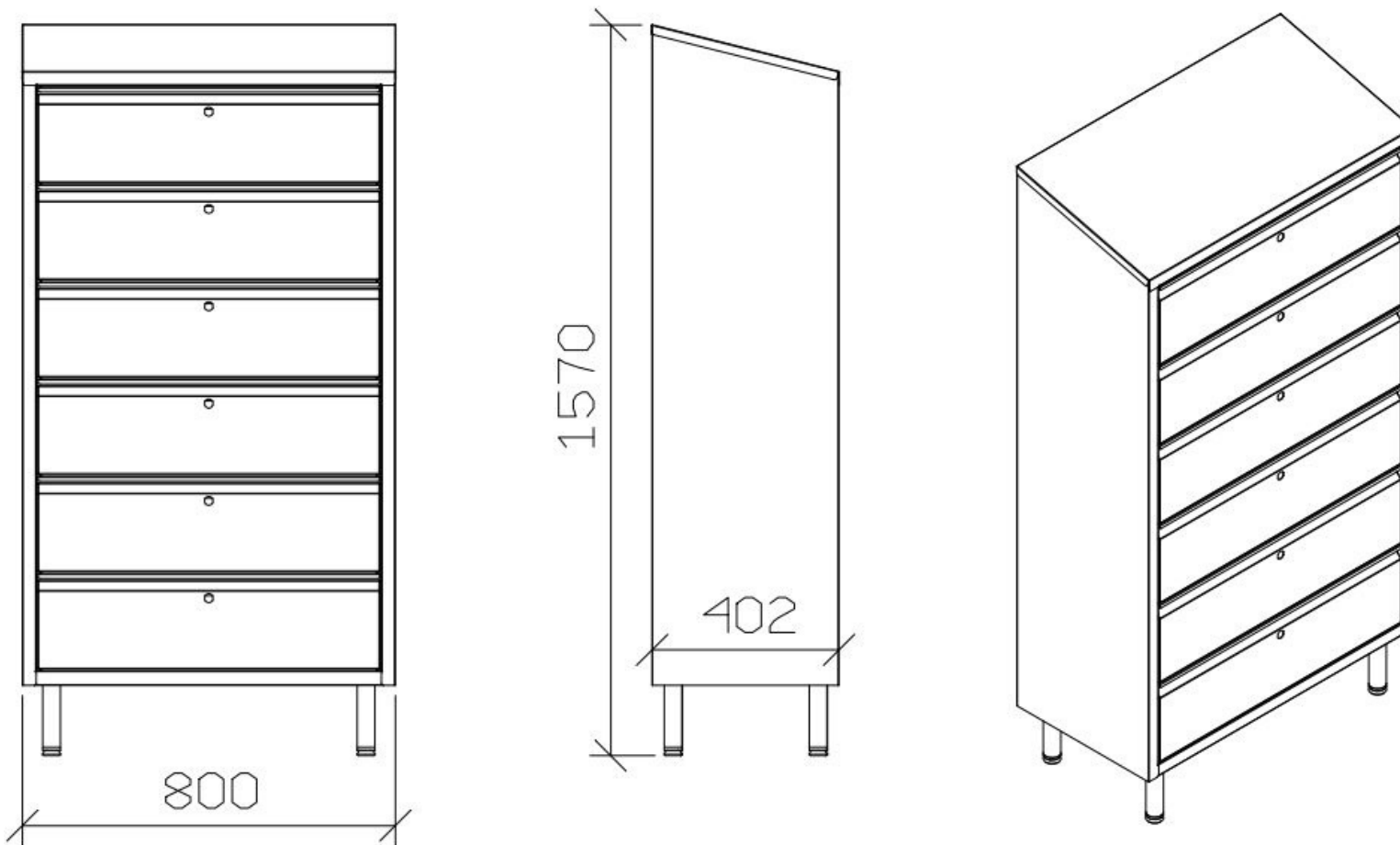

- Stainless steel AISI 304 or AISI 441
- Inclined writing top with raised front edge
- 6 Drawers with key lock
- Adjustable feet $\varnothing 38\text{mm} \times 150\text{H}$
- Dimension mm 800 x 400 x 1.570H